

Chapter 6. Electrolysis

PAGE NO : 131

Solution 1:

- (a) Electrolysis:- It is the process of decomposition of the electrolyte in the molten or aqueous state by discharge of ions at the electrodes on passage of an electric current.
- (b) Electrolyte:- it is a compound which either in aqueous solution or in the molten state allows an electric current to pass through it and is accompanied by discharge of ions and finally into neutral atoms at the two electrodes. For example: Hydrochloric acid.
- (c) Non- electrolyte:- They are substances which do not conduct electricity in the fused or aqueous state. They contain only molecules and do not ionize. For example: Petrol .
- (d) Cation and anion :

Cation : Positively charged ions are called cations. For example:
 Na^+

Anion: Negatively charged ions are called anions. For example: Cl^-

Solution 2:

- (a) Substances which will behave as strong electrolytes:
 NaCl , NaOH , H_2O (pure), dil. H_2SO_4
- (b) Substances which will behave as weak electrolytes : NH_4OH , acetic acid, H_2CO_3
- (c) Substances which are non- electrolytes : urea, glucose

Solution 3:

(a) A strong electrolyte and a weak electrolyte

S. No.	Characteristics	Strong electrolyte	Weak electrolyte
1.	Dissociation into ions in aqueous solution	Almost complete	Partial and not much
2.	Species present in solution	Almost only free ions	Both ions and undissociated molecules
3.	Number of ions present in solution	Very large	Only limited in numbers
4.	Quantity of current conducted	Large amounts, a bulb glows brightly	Only small amounts, a bulb glows dimly
5.	Examples	HCl, NaOH, NaCl	CH ₃ COOH, NH ₄ OH

(a) Electrolytic dissociation and ionization

S.No.	Ionization	Electrolytic dissociation
1.	Formation of positively or negatively charged ions from molecules which are not initially in the ionic state.	Separation of ions which are already present in an ionic compound.
2.	Polar covalent compounds show ionization	Electrovalent compounds show dissociation
3.	For example: HCl,	For example: KCl,

Solution 4:

A steel rod is connected to the negative terminal and a graphite rod to positive terminal of a battery. A silica crucible is filled to about two thirds with solid lead bromide and the rods are dipped into it and is then melted by heating it over a Bunsen burner.

Lead bromide contains:

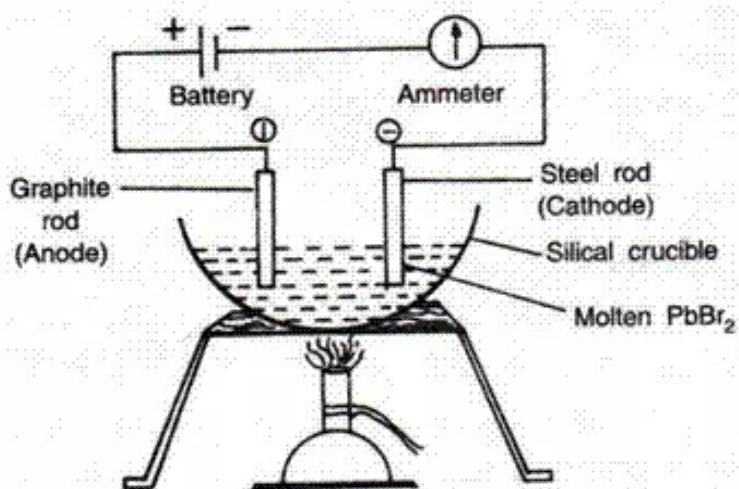
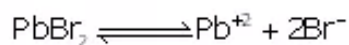

Reaction at cathode: Lead ions are positively charged they get discharged at cathode. It receives two electrons from cathode and changes to atom of lead and get deposited at the cathode.

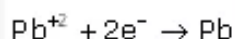

Reaction at the anode: Bromide ions, being negatively charged discharge at anode. It loses its only electron and becomes an atom of bromine. Thus the atoms of bromine combine in pairs to form molecules of bromine which escape as red vapours, at the anode.

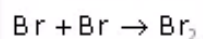
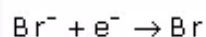

Solution 5:

Three applications of electrolysis are:

1. Electro plating with metals
2. Electrofining of metals
3. Extraction of metals

Solution 6:

- (a) When solid copper sulphate is electrolysed between platinum electrodes the electrolytic reaction will not take place as no electrolytes are formed in solid state.
- (b) When the electrolysis of copper sulphate(aqueous) is electrolysed between platinum electrodes the following reaction follows:

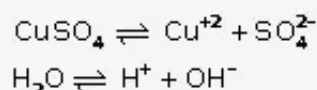

Reaction at cathode: Copper ions and hydrogen ions migrate towards the cathode. Cu^{+2} ions being lower in the electrochemical series are preferentially discharged to hydrogen ions to form neutral copper atoms at platinum cathode.



Reaction at anode: Sulphate ions and hydroxyl ions migrate towards the anode. Hydroxyl ions are preferentially discharged to sulphate ions at anode, to form neutral particles of OH^- . The electrically neutral hydroxyl reacts among themselves to give water and oxygen.

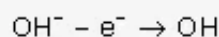

- (c) When Aqueous copper sulphate is electrolysed between copper electrodes then the ions formed are

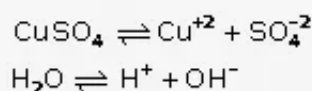

Reaction at the cathode: Copper and hydrogen ions both being positively charged migrate towards the cathode. Copper ions are discharged in preference to hydrogen ions. Copper gains two electrons from the cathode and changes into an atom of copper. The atoms of copper are deposited at the cathode. The atoms of copper are deposited at the cathode and form a layer of pink copper metal which gradually turns reddish brown.

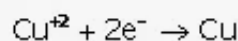

Reaction at the anode: Anode receives electrons from the ions and supplies them to the cathode. The atoms of copper from the anode changes into ions of copper which go into the solution and the electrons liberated in this change are taken up by the anode.

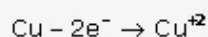

Thus for every copper ion discharged at the cathode, an ion of copper is formed at the anode which goes into the solution. Thus the atoms of copper are deposited at the cathode, the cathode becomes thicker and the atoms of copper from the anode change into ions of copper, the anode becomes thinner .

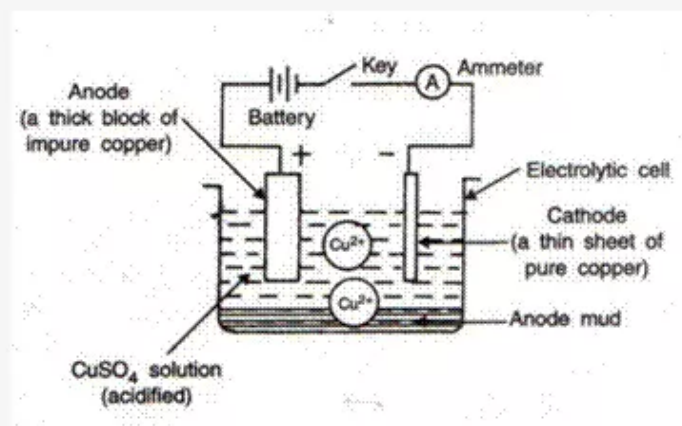

Therefore there is transference of copper atoms from anode to cathode.

Solution 8:

The following are the factors that influence the preferential discharge of ions at the electrode:

- i) **Position of the metallic ion in electrochemical series:** If all the factors remain the same, an ion placed lower in the electrochemical series gets preferentially discharged at the respective electrode in comparison to all those ions, which are placed above it in the series.
- ii) **Concentration of ions in the electrolyte:** Higher the concentration of negative ion in the electrolytic solution, greater is its probability of being discharged at the anode.
- iii) **Nature of the electrode:** If the electrode used is inert i.e made of less reactive material such as graphite, platinum etc, the electrode does not play any role in deciding the preferential discharge of an ion at it.

If the electrode used is active i.e made of active material such as Cu, Ag, Ni etc it takes part in the electrode reaction and plays an important role in deciding the ions which will preferentially be discharged. In such a case, anions migrate to the anode but do not get discharged. Instead the active anode itself loses electrons and form ions.

Solution 9:

- a) Distilled water is a non electrolyte because it does not contain any ions.
- b) The electrolytic cell used in electrolysis of acidulated water is called Hoffmann's Apparatus.
- c) (i) At cathode: Hydrogen ions are H^+ ions. They migrate to the cathode and discharge there. The ions gain electrons from the cathode to form atoms of Hydrogen which combine in pairs to form molecules of Hydrogen.

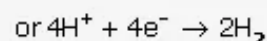
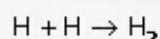
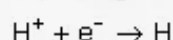

(ii) At anode: Sulphate ions and hydroxyl ions are the anions present in the solution. Both migrate to the anode. OH^- ions are discharged in preference to sulphate ions. The OH^- ions lose their electrons and become electrically neutral particles of OH , which react among themselves to give water and oxygen.

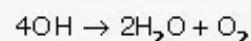
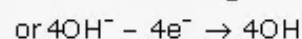
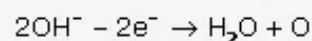

- d) Electrolytic Cell: Hoffmann Voltmeter

Electrolyte: Acidified water

Electrode: Cathode – Platinum Foil, Anode – Platinum Foil

Dissociation of acidified water:

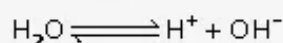
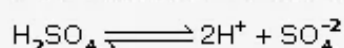

Reaction at cathode:

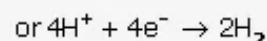
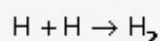
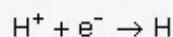

Reaction at anode:

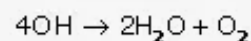
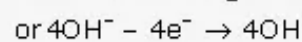
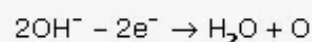

- e) Electrolysis of acidulated water is considered as an example of catalysis because the reaction is catalyzed by acids.

Solution 10:

In order to get a spoon plated with silver a solution of sodium silver siver cyanide can be taken as electrolyte .If silver nitrate was chosen as electrolyte then the deposition of silver will be very fast and hence not very uniform and smooth.

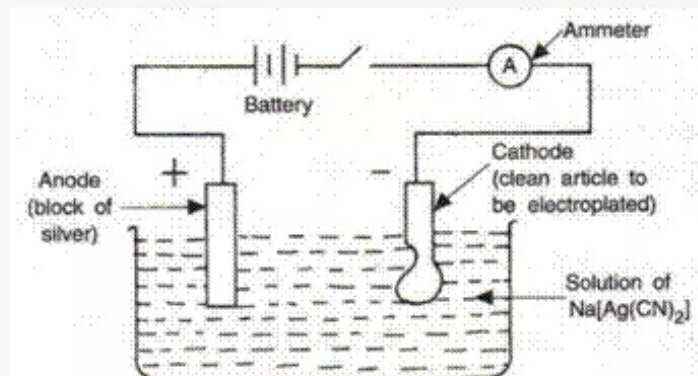

Solution 11:

- (i) Electro refining: It is the process of refining the impure metals through the use of electric current through the use of electric current or electrolysis.
- (ii) Electro metallurgy: It is the process of extraction of metal from its ore through the use of electric current.
- (iii) Anode mud: During electro refining some impurities which are insoluble fall down near the anode and is known as anode mud.

Solution 12:

- a) Anode, lack
- b) current, Cathode , excess
- c) gain , Cations
- d) loose, anions
- e) Electropositive, loose
- f) Electronegative, gain

Solution 13:

- a) The order of discharge of ions is $\text{Cu}^{+2}, \text{Zn}^{+2}, \text{Al}^{+3}, \text{Na}^{+}$ because as the concentration is same, an ion placed lower in electrochemical series get preferentially discharged.
- b) OH^{-} is likely to discharge first in comparison to Br^{-} ions.

Solution 14:

Aluminium is extracted by the electrolysis of fused pure alumina dissolved in fused mixture of cryolite and fluorspar . This mixture lowers the melting point of alumina and increases the electrical conductivity and the electrolysis is carried out in an iron tank lined with gas carbon. This lining of a gas carbon serves as cathode. The anode consists of a number of carbon rods which dip in fused electrolyte. On passing electric current following reaction takes place.

At cathode: $Al^{+3} + 3e^{-} \rightarrow Al$

At anode: $O^{2-} - 2e^{-} \rightarrow O$
 $O + O \rightarrow O_2$

Certain metal oxides are highly stable and so cannot be reduced by conventional reducing agents like coke, carbon monoxide or hydrogen. They are extracted from their oxides or salts by the electrolysis in fused state. For e.g., metals like aluminium, sodium, potassium, magnesium, titanium, calcium etc. are extracted by this method.

Solution 15:

During the electrolysis of copper sulphate using copper electrode, the number of copper ions remains same as that for every copper ions discharged at the cathode , an ion of copper is formed at the anode which goes in the solution. Thus the colour intensity does not change.

Solution 16:

Electrolytic refining is used for the purification of copper . In this case

Cathode: Pure copper strip

Anode: Impure copper

Electrolyte: A solution of copper sulphate and dilute sulphuric acid

When the current is passed through the electrolyte , the copper ions of the copper sulphate solution are attracted to the cathode where they gain electrons and are deposited on pure copper strips. The impure copper loses electrons and passes into solution as soluble copper ions.

At cathode: $Cu^{+2} + 2e^{-} \rightarrow Cu$

At anode: $Cu + 2e^{-} \rightarrow Cu^{+2}$

Solution 17:

The main applications of electrolysis are:

1. Electro plating with metals
2. Electrofining of metals

3. Extraction of metals

Solution 18:

Electrolytic Dissociation is the dissociation of an electrovalent compound into ions in the fused state or in aqueous solution state .

Reversible breakdown of a chemical compound into simpler substances by heating it . The splitting of ammonium chloride into ammonia and hydrogen chloride is an example. On cooling, they recombine to form the salt.

Solution 19:

A solution of NaOH dissociates by electrolytic dissociation.

And fused NaOH dissociates by thermal dissociation.

The similarity between both of these is that they both liberate same ions .

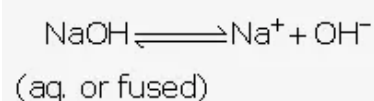

Solution 20:

1. Na_2CO_3
2. NH_3
3. Graphite, Cu electrode
4. NH_4^+
5. Graphite

PAGE NO : 133

Solution 1994-1:

1. The article to be plated must be made Cathode.
2. The ions of the metal which is to be electroplated must be present in the electrolyte.
3. The metal to be plated on the article must be made anode. It needs to be periodically replaced.

Solution 1994-2:

The passage of electricity through an electrolyte occurs through ions furnished by the electrolyte where as the passage of electricity through a copper wire occurs through electrons.

Solution 1995-1:

- (a) The ions of the silver must be present in the electrolyte.
- (b) Anode should be made of pure clean silver.
- (c) The cathode is made of copper wire.
- (d) The equation for the reaction which takes place at the cathode is

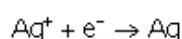

Solution 1995-2:

It is the process of decomposition of an electrolyte in the molten or aqueous state by discharge of ions at the electrodes on the passage of an electric current.

Solution 1995-3:

Pure water does not conduct electricity because the degree of ionization is low. Thus to make it a good conductor of electricity acid is added to it which will increase the degree of ionization.

Solution 1996-1:

Substance which contain

1. Ions only:- HCl
2. Molecules only:- Petrol
3. Both ions and molecules:- CH₃COOH

Solution 1996-2:

1. **Electrolyte** is a compound which either in aqueous solution or in molten state allows an electric current to pass through it and is accompanied by discharge of ions and finally into neutral atoms at the two electrodes.
2. **Non- electrolyte** are substances which do not conduct electricity in fused or aqueous state. They contain only molecules and do not ionize. For example: petrol, alcohol.
3. If the electrolyte is described as 'strong electrolyte' it means it completely dissociates into its constituting ions in aqueous solution.

Solution 1996-3:

1. As for every copper ion discharged at the cathode, an ion of copper is formed at the anode which goes into the solution. Since atoms of copper are deposited at the cathode, the cathode becomes thicker and as the atoms of copper from the anode change into ions of copper, the anode becomes thinner.
2. When platinum rods are used as electrodes, then the blue colour of copper sulphate solution fades and sulphuric acid is formed. This is because oxygen is liberated at anode and copper metal is deposited at cathode.
3. Practical application of electrolysis of copper sulphate solution: This is the basis for purification of copper. Other metals like Zinc, Nickel, Silver. Lead can also be purified.

Solution 1997-1:

Lead Bromide should be in the molten state if it has to conduct electricity.

Solution 1997-2:

Lead Bromide contains only positively charged lead ions and negatively charged bromide ions.

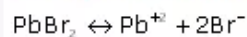

Solution 1997-3:

Equations for the reactions, which takes place at the electrodes:-

At Cathode:

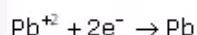

At anode:

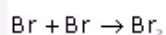
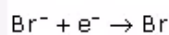

Solution 1998-1:

1. Electrolyte
2. Nickel
3. Cathode
4. Anode
5. Cations

PAGE NO : 134

Solution 1999-1:

The electrolysis of lead bromide liberates lead at cathode and bromine at anode.

Solution 1999-2:

When a fused metallic chloride is electrolyzed, the metal is obtained at cathode.

Solution 2000-1:

1. **Strong electrolytes** – dilute hydrochloric acid, dilute sulphuric acid, Ammonium chloride
2. **Weak electrolyte** – Acetic acid, Ammonium hydroxide
3. **Non-electrolytes** – Carbon tetrachloride

Solution 2002-3:

	Anode	Electrolyte	Cathode
Silver plating of a spoon	Plate of pure clean silver	Solution of potassium argentocyanide	Cleaned article to be electroplated
Purification of copper	Impure Copper	A solution of copper sulphate and dilute sulphuric acid	Thin strip of pure copper

Solution 2002-1:

1. molecules.
2. will not

Solution 2002-2:

1. When sulphuric acid is added to water it becomes good conductor as addition of sulphuric acid causes dissociation of water molecules into H^+ and OH^- ions which are then responsible for conduction of electricity by pure water. The water thus obtained is called acidified water.
2. Cathode, Anode

Solution 2003-1:

electricity, chemical

Solution 2004-2

1. Molecules are found in a liquid compound which is a non-electrolyte.
2. Non ionized molecules; H^+ and X^- particles will be present in dilute solution.
3. Loss, Gain
4. The ions of the metal which is to be electroplated on the article must be present in a solution.
5. Redox reaction is one in which oxidation and reduction occurs simultaneously.
6. Similarly in case of electrolysis:
 - o **At cathode:** The cations gain electron and become neutral. As the electrons are gained the ion is said to be reduced.
 - o **At anode:** The anions lose electron to form neutral atoms. As the electrons are lost the ion is said to be oxidized.Hence in electrolysis also the oxidation and reduction occurs hence it is an example of Redox reaction.

Solution 2004-1:

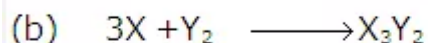
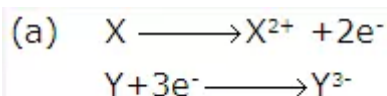

(c) (i). Electroplating of metals.

(ii). Electrorefining of metals.

(d) If the compound formed between X and Y is melted and an electric current passed through the molten compound, the element X will be obtained at the cathode and Y at the anode of the electrolytic cell.

PAGE NO : 135

Solution 2005-1:

1. Copper metal is solid and has no mobile ions whereas an electrolyte should dissociate into oppositely charged ions to conduct the electric current.
2. Hydrogen is released at the cathode when acidulated water is electrolyzed.
3. In sodium chloride, Na^+ and Cl^- ions are not free to carry the electric current.
4. (a) Reduced
(b) Higher

Solution 2006-1:

(a) (i) Electrode A – Anode

Electrode B – Cathode

(ii) Electrode A.

(b) AgNO_3 will turn blue.

(c) Reaction at cathode:

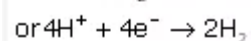
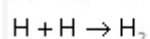
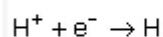

Reaction at anode:

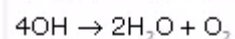
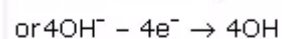
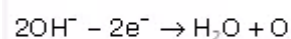

Solution 2006-2:

(a) (i) Electrode A – Anode

Electrode B – Cathode

(ii) Electrode A.

(b) AgNO_3 will turn blue.

(c) Reaction at cathode:

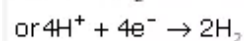
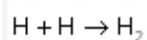
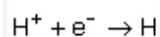

Reaction at anode:

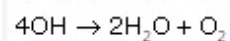
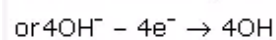
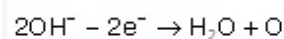

Solution 2007-1:

1. Molten ionic compound – Strong electrolyte
2. Carbon tetrachloride- Non-electrolyte
3. An aluminium wire- Metallic conductor
4. A solution containing solvent molecules, solute molecules and ions formed by the dissociation of solute molecules- weak electrolyte
5. A sugar solution with sugar molecules and water molecules- Non-electrolyte

Solution 2007-2:

(a) Bauxite is reacted with sodium hydroxide to obtain pure aluminium oxide.

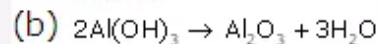

(c) Carbon serves both as anode and cathode.

(d) Reaction at cathode:

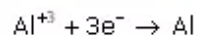

(e) Reaction at cathode:

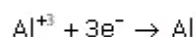

(f) Reaction at anode:

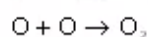
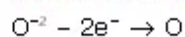

PAGE NO : 136

Solution 2008-1:

(d) Lead is deposited at the cathode

Solution 2008-2:

(a) The reaction takes place at anode. Yes, this is an example of oxidation.

(b) Cu^{+2} will be discharged first.

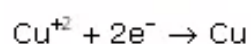

(c) Carbon tetrachloride is a non-electrolyte as it is a covalent compound and contains only molecules.

Solution 2009-2:

$\text{Mg}(\text{OH})_2$ as it is basic while rest are amphoteric.

Solution 2009-3:

Molten Lead bromide conducts electricity.

Solution 2009-4:

1. Nickel ions move towards cathode.
2. Nickel ions.