

## Chapter 9A. Ammonia

---

PAGE NO : 204

### Solution 1:

Ammonia is found both in free state and in combined state. In free state, it is formed in traces amount by decaying urine and other organic matter.

In combined state, ammonia is found as ammonium salts mainly as ammonium chloride and ammonium sulphate.

### Solution 2:

1. (i) **Liquid ammonia** – Compressed ammonia gas at 6 atmospheric pressure. Chemical formula -NH<sub>3</sub>
2. (ii) **Liquor ammonia** – It is saturated solution of ammonia in water. It is very dilute solution of ammonium hydroxide (NH<sub>4</sub>OH).
3. A saturated solution of ammonia in water is called liquor ammonia Fortis.

### Solution 3:

(i) Ammonium chloride is heated with calcium hydroxide (an alkali), in ratio of 2: 3 by weight, to produce ammonia.

Reactants should be dry and in grounded state. The reactants are heated to get the products.

Balanced reaction:

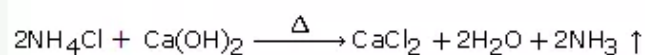

**Key:** Laboratory Preparation of Ammonia

(ii) Ammonia gas is collected in an inverted dry gas jar by the downward displacement of air.

(iii) The substance used for drying ammonia gas is quicklime (calcium oxide). Concentrated sulphuric acid, anhydrous calcium chloride and phosphorus pentoxide cannot be used for drying ammonia gas because ammonia being basic reacts with them, and the following reaction takes place

Conc. H<sub>2</sub>SO<sub>4</sub> reacts with ammonia to form ammonium sulphate.

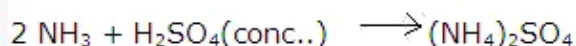

Phosphorus pentoxide reacts with ammonia to form ammonium phosphate.

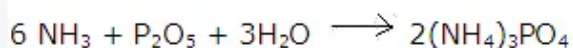

Anhydrous calcium chloride combines with ammonia to form addition compound.



#### Solution 4:

- (i) Nitrogen gas
- (ii) Copper
- (iii) Nitrogen and water vapour
- (iv) Quick lime (calcium oxide)
- (v) Warm water
- (vi) Phenolphthalein
- (vii) Nitrogen trichloride and hydrogen trichloride
- (viii) Liquid ammonia
- (ix) Ammonia solution
- (x) Ammonium chloride
- (xi) Ammonium chloride
- (xii) Ammonium nitrate
- (xiii)  $\text{HCl} + \text{NH}_3 \longrightarrow \text{NH}_4\text{Cl}$
- (xiv)  $\text{Mg}_3\text{N}_2 + 6 \text{H}_2\text{O} \rightarrow 3 \text{Mg}(\text{OH})_2 + 2 \text{NH}_3$

#### Solution 5:

- (a) Haber's Process
- (b) The reactants nitrogen and hydrogen combine at low temperature and high pressure in presence of catalyst to form maximum yield of ammonia. The balanced equation for the reaction is:

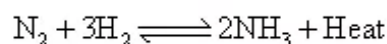

- (c) The mixture of dry nitrogen and dry hydrogen is mixed in the ratio of 1 : 3 by volume to produce ammonia.
- (d) Source of hydrogen: Hydrogen is generally obtained from water gas by Bosch process.

Source of nitrogen: Nitrogen is obtained from air by its liquefaction and fractional distillation.

- (e) (i) Finely divided iron acts as catalyst which alters the rate of reaction, but itself does not undergo any chemical change.  
  
(ii) Molybdenum acts as promoter which increase the efficiency of the catalyst.
- (f) The gases leaving the catalyst chamber are cooled by passing through condensing pipes where ammonia gets liquefied and is collected in receiver.

**Key:** Haber's Process

### Solution 6:

Ammonia is highly soluble in water. This can be demonstrated by Fountain experiment.

- We take a round bottom flask filled with ammonia gas.
- The flask is closed with a two holed rubber stopper, one for the jet tube and the other for a dropper filled with water.
- The flask is fixed to the stand in an inverted position.
- The free end of the jet tube is dipped into a beaker containing red litmus solution.
- When the bulb of dropper is pressed, it is observed that red litmus solution rises up and strikes the wall of the flask and spreads in form of fountain, which is blue in colour.

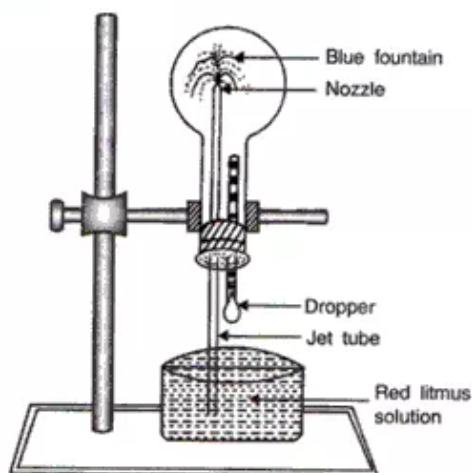
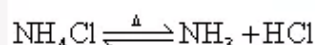

Fig. : Fountain experiment

### Solution 7:

(i) Action of heat on ammonium chloride is reversible. When heated, it decomposes to form ammonia and hydrogen chloride. When the products are cooled, they recombine to form ammonium chloride.



This is thermal dissociation reaction.

(ii) Ammonium nitrate on heating completely disappears, escaping in the form of water vapour and nitrous oxide.

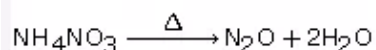

This is thermal dissociation reaction.

PAGE NO : 205

### Solution 8:

#### 1. Liquid ammonia is used as refrigerant as:

- It is highly volatile
- It has high specific latent heat of vaporization. 1 mole (17g) of liquid ammonia vaporises by absorbing 5.7 kcal of heat from the surroundings, which is thereby cooled.
- It easily liquefies under pressure at room temperature.

2. Ammonia emulsifies fats and grease. Thus it is used to clean oils, fats and body grease etc. from clothes.

3. Liquid hydrogen is dangerous to transport as it is highly combustible. Thus, hydrogen is converted to liquid ammonia and transported in cylinders. Later it is catalytically converted to hydrogen.

**Key:** Uses of ammonia

### Solution 9:

#### (a) Three uses of ammonium chloride :

1. For cleaning metal surfaces before soldering, tinning, etc.
2. In Leclanche cell and in dry cell.
3. In medicine and dyeing.

(b) Ammonium hydroxide precipitates hydroxides of metals when it is added to aqueous solution of their salts. The precipitate of metal hydroxides differ in colour and solubility and hence ammonium hydroxide is used in qualitative analysis.

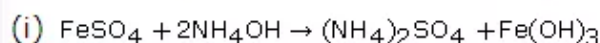

The colour of precipitate is dirty green, which is insoluble in excess of ammonium hydroxide.

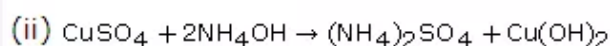

The colour of precipitate is bluish white, which is soluble in excess of ammonium hydroxide.

### Solution 10:

Liquid ammonia	Liquid ammonia fortis
1.It is obtained by compressing ammonia gas at 6 atmospheric pressure.	1.It is a saturated solution of ammonia in water.
2.It is used as refrigerant.	2.It is used as a laboratory agent.

### Solution 11:

Ammonia is a strong reducing agent. It is oxidised to nitrogen by removal of hydrogen, when it react with oxidizing agent.

#### (i) Reduction of chlorine

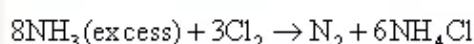

#### (ii) Reduction of copper (II) oxide

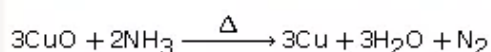

Black                      Reddish brown

#### (iii) Reduction of lead (II) oxide

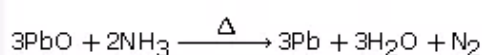

Yellow                      Grey

**Key:** Ammonia is a strong reducing agent.



### Solution 12:

#### Structure of ammonia

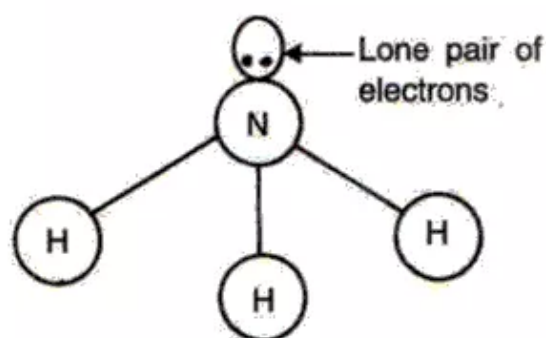

#### Structure of ammonia

The presence of lone pair of electrons on the nitrogen atom makes ammonia basic in nature in its aqueous solution. Aqueous solution of ammonia dissociates partially to produce hydroxyl ion.

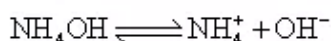
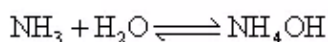

**Key:** Aqueous solution of ammonia is alkaline in nature.

### Solution 13:

An aqueous solution of ammonia is prepared by dissolving ammonia in water. Ammonia is highly soluble in water.

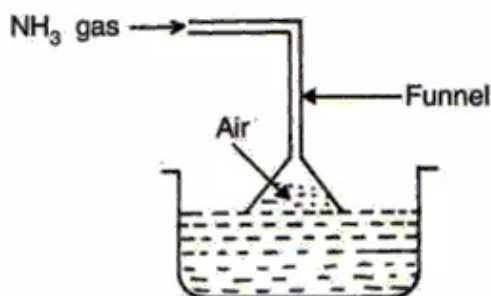

**Fig.** Funnel arrangement in preparation of aqueous ammonia solution

The funnel arrangement is used to prepare aqueous solution of ammonia. In this method, ammonia gas is introduced through a funnel tube where the rate of dissolution of ammonia is faster than it is produced. This creates a partial vacuum, in delivery tube, resulting in low pressure. Thus, water is forced in to equalise the pressure. To overcome this problem of back suction, the funnel is attached to outer end of the delivery tube and mouth of funnel just dips into the water in the trough.

Two advantages of this method:

- (i) Prevents back suction of water into the flask.
- (ii) Provides a larger surface area for the absorption of the gas.

**Key:** Ammonia is highly soluble in water.

**Solution 14:**

(a) Two fertilizers manufactured from ammonia: Urea, ammonium sulphate, ammonium nitrate.

(b) Fertilizer from ammonia: Urea

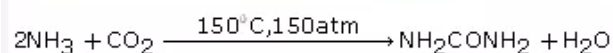

**Key:** Ammonia is used in manufacture of fertilizer.

**Solution 15:**

- (i) Once the reaction starts, further heating is not required because the reaction is exothermic. The heat evolved is sufficient to maintain the optimum temperature.
- (ii) Ammonium nitrate is explosive in nature and it decomposes to give nitrous oxide and water. Thus, it is not used in the laboratory preparation of ammonia.
- (iii) Calcium hydroxide is preferred as it is cheap and not deliquescent like NaOH or KOH.
- (iv) Liquid ammonia is a polar covalent compound and neutral to litmus. Liquor ammonia is solution of ammonia in water, which is weakly basic in nature. It turns red litmus blue.
- (v) Presence of moisture may result in formation of ammonium hydroxide. Thus dry  $\text{N}_2$  and  $\text{H}_2$  must be used in the Haber's process.
- (vi) A promoter is a substance that is added to increase the efficiency of a catalyst.
- (vii) Aqueous solution of ammonia that is ammonium hydroxide dissociates partially to hydroxyl ions. Thus, it conducts electricity.

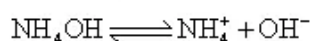
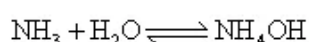

- (viii) Ammonia is highly soluble gas in water and so cannot be collected over water.
- (ix) Ammonia is formed by decaying urine and other organic matter. Thus it is present in sewage water.
- (x) Ammonium hydroxide precipitates hydroxides of metals, which differ in colour and solubility in excess of ammonium hydroxide. Thus it is used in identification of metal ions.

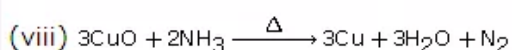
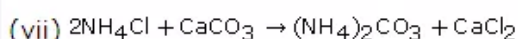
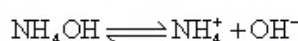
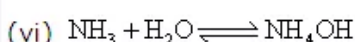
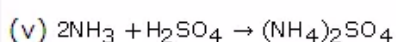
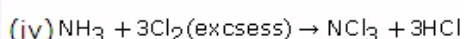
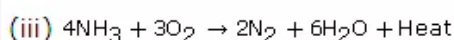
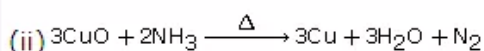
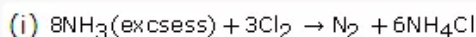
**Solution 16:**

### Solution 17:

- (i) When excess ammonia is mixed with chlorine, ammonium chloride and nitrogen is formed.

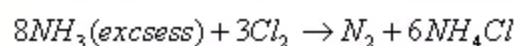

- (ii) When excess ammonia is mixed with chlorine, ammonium chloride and nitrogen is formed.

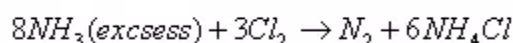

- (iii) The filter paper turns into deep pink suggesting that ammonia solution is alkaline or basic in nature.

- (iv) On passing ammonia over heated lead oxide yellow coloured lead monoxide is reduced to grey coloured lead metal.

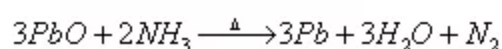

Yellow

Grey

- (v) On adding ammonium solution to ferric chloride solution we get ammonium chloride and reddish brown precipitate of ferric hydroxide which is insoluble in excess of ammonium solution.

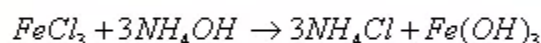

- (vi) Initially when ammonium solution is added to aqueous solution of copper sulphate a bluish precipitate of copper hydroxide is obtained which dissolves in excess of ammonium hydroxide.

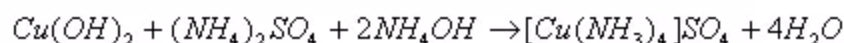
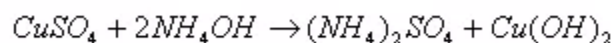

- (vii) Ammonia affects the lachrymal glands and brings tears to the eyes.

PAGE NO : 206

### Solution 18:

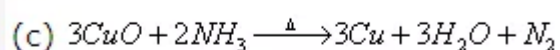
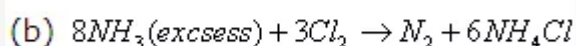
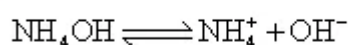
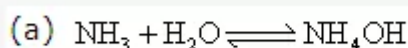

**Solution 19:**

(i)

Dry ammonia	Aqueous ammonia
Dry ammonia is neutral to indicators.	Aqueous ammonia shows alkaline or basic behaviour with indicators. It turns red litmus blue.

(ii)

	Reaction of excess ammonia with chlorine	Reaction of ammonia with excess chlorine
1	It forms ammonium chloride and nitrogen.	It forms nitrogen trichloride and hydrogen chloride
2	$8\text{NH}_3(\text{excess}) + 3\text{Cl}_2 \rightarrow \text{N}_2 + 6\text{NH}_4\text{Cl}$	$\text{NH}_3 + 3\text{Cl}_2(\text{excess}) \rightarrow \text{NCl}_3 + 3\text{HCl}$
3	The yellow green colour of chlorine gas disappears and white ammonium chloride is formed.	Nitrogen trichloride is a yellow coloured highly explosive liquid.

(iii)

Aqueous ferrous	Ferric sulphate solution
When ammonium solution is added to aqueous solution of ferrous sulphate a dirty green precipitate of ferrous hydroxide is obtained which is insoluble in excess of ammonium solution. Hydroxide.  $\text{FeSO}_4 + 2\text{NH}_4\text{OH} \rightarrow (\text{NH}_4)_2\text{SO}_4 + \text{Fe}(\text{OH})_2$	On adding ammonium solution to ferric sulphate solution we get ammonium sulphate and reddish brown precipitate of ferric hydroxide which is insoluble in excess of ammonium solution.  $\text{Fe}_2(\text{SO}_4)_3 + 6\text{NH}_4\text{OH} \rightarrow 3(\text{NH}_4)_2\text{SO}_4 + 2\text{Fe}(\text{OH})_3$

**Solution 20:**

- (i) Use of Ammonium Chloride  
-Used in Leclanche cell and dry cell
  - (ii) Use of Ammonium Sulphate  
-Used as a fertilizer
  - (iii) use of Ammonium nitrate  
-Used in fireworks
  - (iv) Use of Ammonium Carbonate  
-Used in baking powder
- Test of ammonia and ammonium ions:**
    - Ammonia gas has a characteristic pungent smell
    - A glass rod dipped in concentrated hydrochloric acid and is introduced into the gas produces thick white fumes of ammonium chloride.

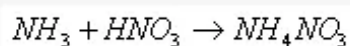

**Solution 21:**

(A)            (B)

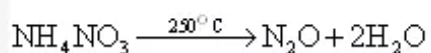

(C)            (D)

**Solution 22:**

(i) Ammonia gas on reacting with aqueous solution of zinc chloride produces white gelatine like precipitate of zinc hydroxide.

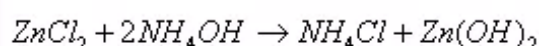

(ii) Ammonia gas on reacting with aqueous solution of ferrous sulphate produces dirty green precipitate of ferrous hydroxide.

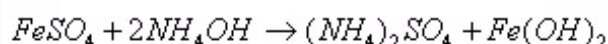

(iii) Ammonia gas on reacting with aqueous solution of ferric chloride produces reddish brown precipitate of ferric hydroxide.

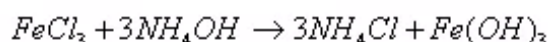

(iv) Ammonia gas on reacting with aqueous solution of lead nitrate produces white precipitate of lead hydroxide.

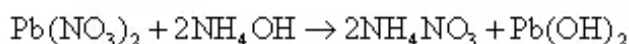

(v) Ammonia gas on reacting with aqueous solution of copper sulphate produces bluish white precipitate of cupric hydroxide.

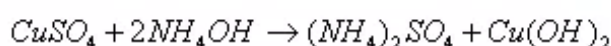

(vi) Ammonia gas on reacting with aqueous solution of Chromium chloride produces green precipitate of chromium tri hydroxide.

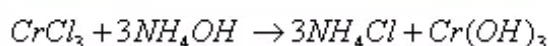
**Solution 1992-1:**

Silver chloride

**Solution 1992-2:**

Ammonia is highly soluble gas in water and so cannot be collected over water.

**Solution 1992-3:**

Ammonia is the odd one out.

Ammonia forms weakly basic solution when dissolved in water.

The others give acidic solution when dissolved in water.

**Solution 1992-4:**

Ammonium chloride on heating with an alkali produces ammonia with other products.

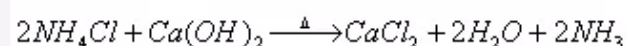
**Solution 1992-5:**

1. Ammonia is used in the manufacture of fertilisers such as ammonium sulphate, ammonium nitrate, etc.
2. It is used in the industrial preparation of nitric acid by Ostwald's process.

**Solution 1993-1:**

Initially when ammonium solution is added to aqueous solution of copper sulphate a bluish precipitate of copper hydroxide is obtained which dissolves in excess of ammonium hydroxide.

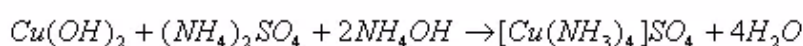
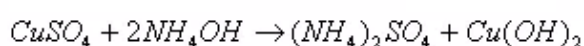
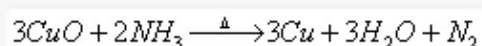
**Solution 1993-2:**

Black

Reddish brown

**Solution 1994-1:**

Magnesium on burning in air produces magnesium nitride.

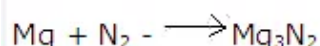

When this magnesium nitride comes in contact with water ammonia gas is released.



**Key:** Ammonia is formed from metal nitrides

**Solution 1994-2:**

	Name of the products	Name of the catalyst	Approximate temperature	Approximate pressure
Haber's Process	Ammonia	Iron	450 - 500°C	200-900 atmospheres

**Solution 1994-3:**

Ammonium chloride on heating with an alkali produces ammonia with other products.

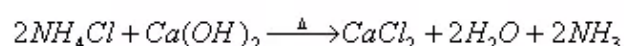

**Solution 1995-1:**

The cation is  $\text{Cu}^{2+}$  ion. Solution B is copper sulphate. It is bright blue in colour.

**Solution 1995-2:**

**Three ways to identify ammonia gas:**

1. It is a pungent smell gas.
2. It gives white precipitate when bubbles through a solution of lead nitrate.
3. It gives a brown colour or precipitate when treated with Nessler's reagent.

**Solution 1995-3:**

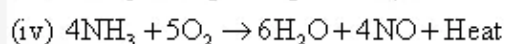
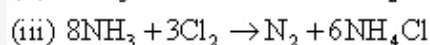
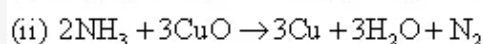
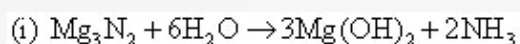

**Solution 1995-4:**

This reaction shows that ammonia is a reducing agent.

**Solution 1995-5:**

This process is called as Ostwald's Process .The catalyst used is platinum.

**Solution 1995-6:**

During laboratory preparation of ammonia, it is passed through a drying tower containing quicklime (calcium oxide).

Ammonia is collected in an inverted dry gas jar by the downward displacement of air.

**Solution 1995-7:**

Ammonia gas

**Solution 1996-1:**

Ammonia forms ammonium hydroxide and turns red litmus blue as it is alkaline in nature.

**Solution 1996-2:**

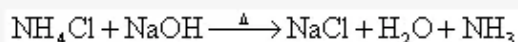

**Solution 1996-3:**

Haber's process is used in industrial preparation of ammonia.

Gaseous inputs in Haber's process are dry nitrogen and dry hydrogen gas. They are mixed in the ratio of 1:3 by volume.

**The following conditions favour maximum yield of ammonia:**

1. Low temperature
2. High pressure
3. Use of catalyst

The gases after reaction pass through condensing pipes of cooling chamber where ammonia gets liquefied and is collected in receiver.

Ammonia can also be collected by downward displacement of air.

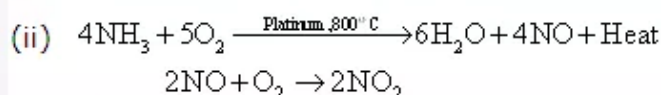
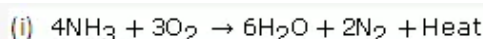
**Solution 1997-1:**

(iii) (a) Catalyst used is Platinum

(b) The catalyst glows red hot as this reaction is an exothermic reaction.

(c) Ostwald's Process

**Solution 1997-2:**

(i) When ammonia dissolve in water, it form ammonium hydroxide which dissociates into  $\text{NH}_4^+$  and  $\text{OH}^-$  ion. Therefore it become soluble in water.

(ii) (a) Aqueous solution of ammonia turns red litmus blue stating that it is having basic ions. (b) It precipitates hydroxides of metals.

(iii) An aqueous solution of ammonia i.e. ammonium hydroxide reacts with acid to produce ammonium salt and water.

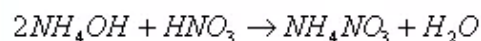
**Solution 1998-2:**

Ammonium salts are used as fertilizers in fields.

**Solution 1998-3:**

(a) Magnesium nitride ( $\text{Mg}_3\text{N}_2$ )



(c) Ammonia is a good reducing agent.

**Solution 1998-1:**

Dry ammonia are neutral to litmus. An aqueous solution of ammonia turns red litmus blue stating that it is basic in nature.

**PAGE NO : 208**

**Solution 1998-4:**

(i) The reactants nitrogen and hydrogen combine to form ammonia at low temperature, high pressure in presence of catalyst to for maximum yield of ammonia. The balanced equation for the reaction is:

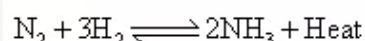

(ii) Iron acts as catalyst.

(iii) Since the forward reaction occurs with decrease in volume, according to Le Chatelier's principle, high pressure favours the formation of ammonia.

**Key:** Haber's process



**Solution 1998-5:**

Ammonia (vapour density(V.D)= 8.5) is less dense than air (vapour density (V.D.)= 14.4) and so is lighter than air.

Fountain experiment proves that ammonia is highly soluble in water.

The balanced equation for the reaction between ammonia and sulphuric acid is

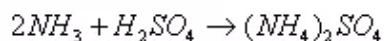
**Solution 1991-1:**

1. Ammonia
2. Nitrogen

**Solution 2001-1:**

Ammonia

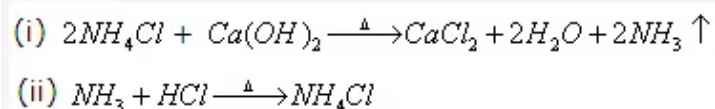
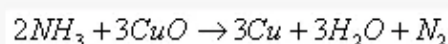
**Solution 2001-2:****Solution 2001-3:****Solution 2001-4:**

Aqueous solution is acidic in nature due to presence of hydrogen ion.

Aqueous solution of ammonia is weakly basic in nature due to presence of hydroxyl ion.

**Solution 2002-2:**

Thermal dissociation.

**Solution 2002-1:**

Action of heat on ammonium chloride is reversible. When heated, it decomposes to form ammonia and hydrogen chloride. When the products are cooled, they recombine to form ammonium chloride.

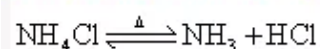

Ammonium nitrate on heating completely disappears, escaping in the form of water vapour and nitrous oxide.

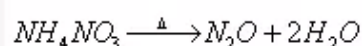
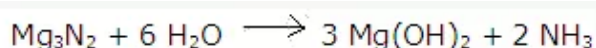
**Solution 2003-1:****Solution 2003-2:**

Ammonia is collected by downward displacement of air.

**Solution 2003-3:**

Ammonia is highly soluble in water and so it is not collected over water.

**Solution 2003-4:**

Quick lime (calcium oxide) is used as a drying agent for ammonia.

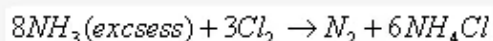
**Solution 2004-1:****Solution 2004-4:**

(i) The reactants nitrogen and hydrogen combine to form ammonia at low temperature, high pressure in presence of catalyst to for maximum yield of ammonia. The balanced equation for the reaction is:

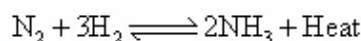

(ii) The gases which leave the catalyst chamber contain ammonia and unreacted nitrogen and hydrogen gas. The gases leaving the catalyst chamber are cooled by passing through condensing pipes where ammonia gets liquefied and is collected in receiver.

**Solution 2005-1:**

(i) This shows that ammonia molecule accept  $\text{H}^+$  ion from water to form ammonium ion.

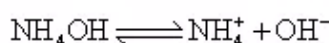
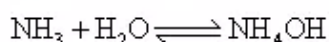

(ii) When ammonia dissolves in water, the hydroxyl ion is also formed.

(iii) The precipitation of metal hydroxides from their aqueous solution confirms the presence of  $\text{OH}^-$  ion in the solution.

**PAGE NO : 209****Solution 2005-2:**

(i) Ammonium chloride on heating with an slaked lime produces ammonia with other products.

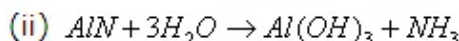
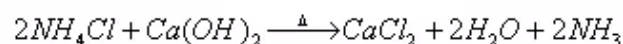
**Solution 2006-1:**

Ammonia gas on reacting with aqueous solution of lead nitrate produces white precipitate of lead hydroxide, which is insoluble in excess of ammonium hydroxide.

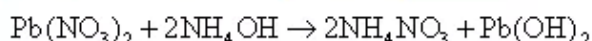
**Solution 2006-2:**

Ammonia gas on reacting with aqueous solution of lead nitrate produces white precipitate of lead hydroxide, which is insoluble in excess of ammonium hydroxide.

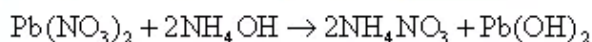
**Solution 2007-1:**

By the pungent smell of ammonia gas.

**Solution 2007-2:**

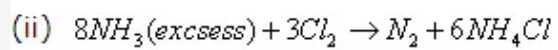
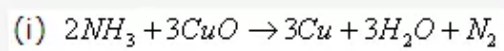

**Solution 2008-1:**

(c) Magnesium nitride